

Dreidel

The "dreidel" is a traditional Chanukah spinning toy. The four Hebrew letters that appear on its sides – nun, gimmel, hey, shin – stand for the Hebrew words "Nes Gadol Hayah Sham" - "A great miracle happened there." This refers to the miraculous victory of the few Maccabees over the might of the Greek Empire. In Israel, instead of the letter "shin" they use the letter "peh," which stands for "Poh." "Poh" means "here," which indicates that a great miracle happened here, not there.

Our origami dreidel is made from two identically folded sheets of different colors.

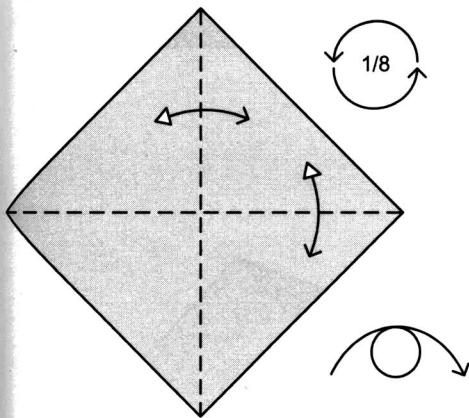
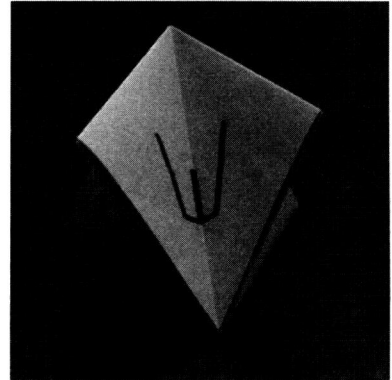

1. Begin with the color side up. Valley-fold the left corner to the right and unfold. Valley-fold the top corner to the bottom and unfold. Rotate 1/8 and turn over.

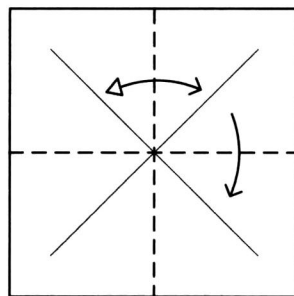

2. Valley-fold left side to right and unfold. Valley-fold the top to the bottom.

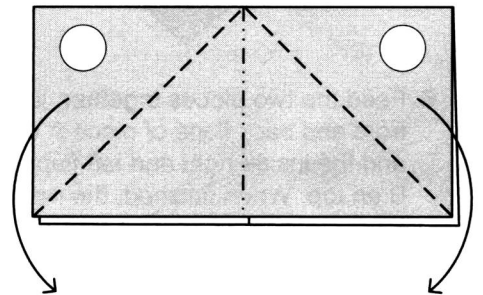

3. Grasp the model at the circles and swing the lower corners down and together. As you do this, flaps will emerge from the center of the model in front and back.

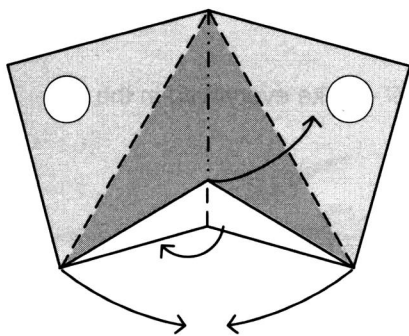

Step 3 in progress

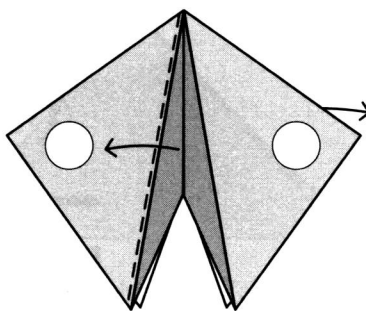

4. Swivel the front flap to the left, and the rear flap to the right. Then lay the model flat.

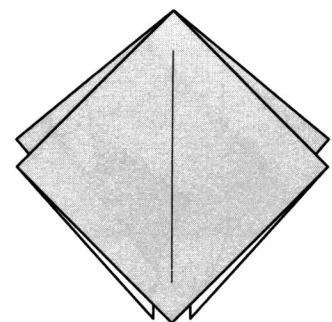

5. Half the dreidel is complete. Make another piece using a different color.

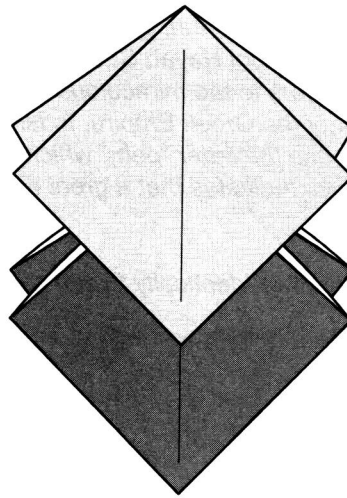
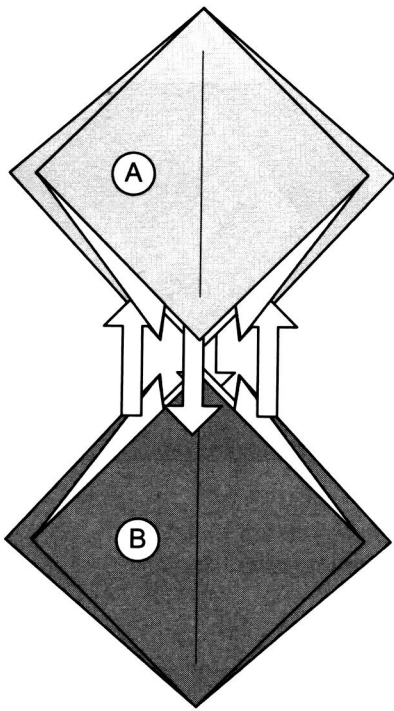

Step 6 in progress

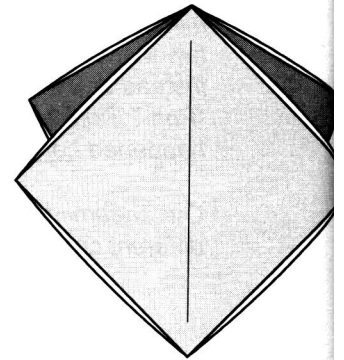





The Dreidel

6. Feed the two pieces together, laying the front and back flaps of piece A on top, and the inside right and left flaps of piece B on top. When finished, the model will have sides of alternating colors.

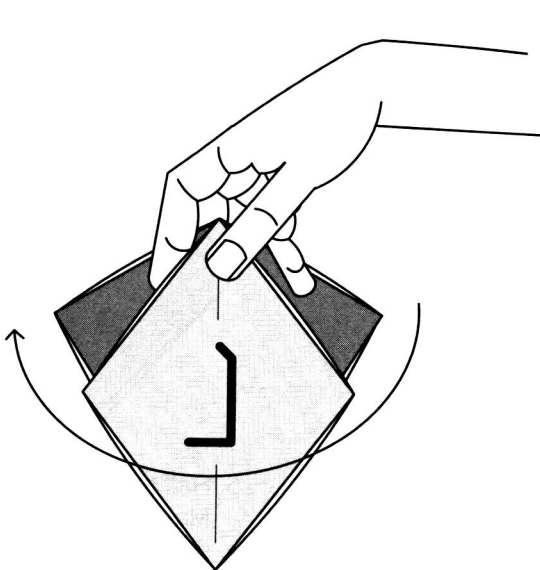
Write the four Hebrew letters as shown below on the dreidel, one on each of the four faces.

To play, first distribute an equal number of tokens (pennies, nuts, chocolate coins, etc.) to each player. The player holds the model as shown, spins it, and does what the letter that ends up on top says to do, based on the key below. Then the dreidel passes to the next player.



- 
Nun – Nothing happens.
- 
Gimmel – Take everything in the pot.
- 
Hey – Take half the pot.
- 
Shin – Put one token into the pot.

Menorah with Candles

A nine-branched candelabra, called a "menorah," is lit each evening of the eight-day festival of Chanukah, with one candle added each night, and one, called the "shammash" or "helper," to light the others. The candles recall the miracle of the lamp, discovered in the ruined Temple, which contained only enough oil to burn for one day, but instead burned for eight.

This model has two parts – the menorah itself and the candles. A triangular flap extends above the candles to indicate the shammash.

For the menorah, use silver or gold foil-backed paper. For the candles, use paper the color of fire – either yellow or orange.

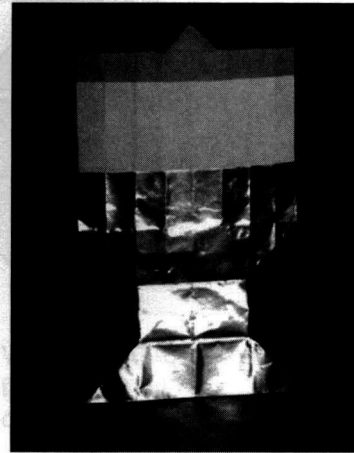

Menorah

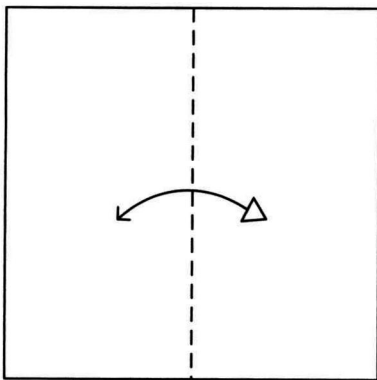

1. Begin with the white side up. Valley-fold and unfold the model side to side.

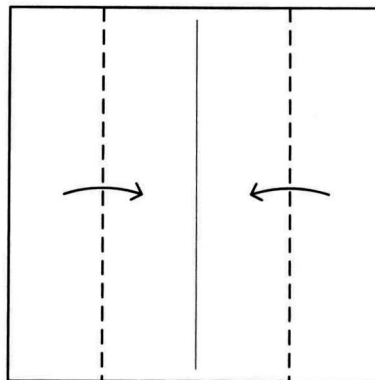

2. Valley-fold both sides to the center.

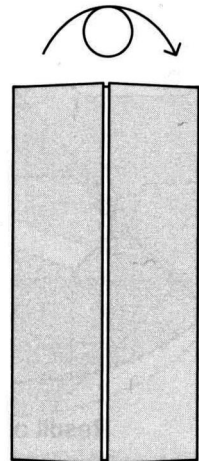

3. Turn the model over.

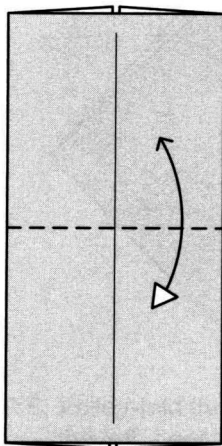

4. Valley-fold and unfold the bottom edge to the top.

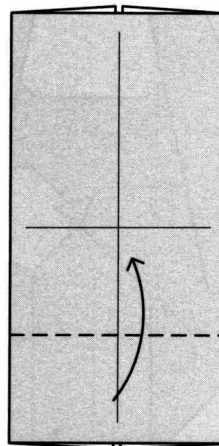

5. Valley-fold the bottom edge to the crease you made in the previous step.

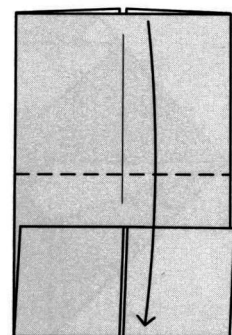

6. Valley-fold the top edge to the bottom edge.

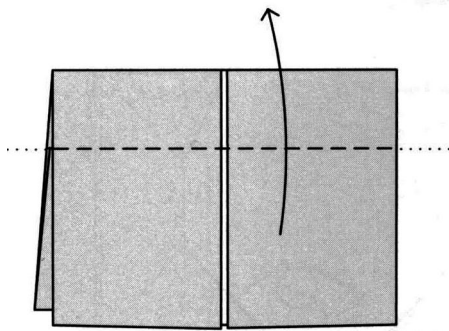

7. Valley-fold the bottom edge up, making a crease that lies along the top edge of the underlying flap (shown with a dotted line).

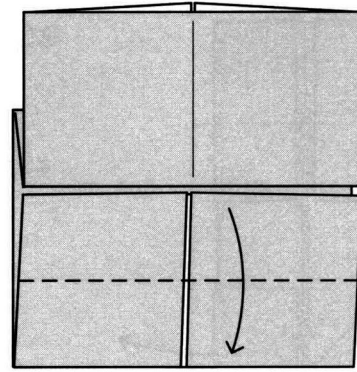

8. Valley-fold the top edge of the lower flap to lie along the bottom.

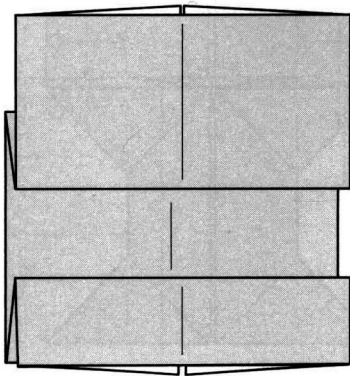

9. Turn the model over.

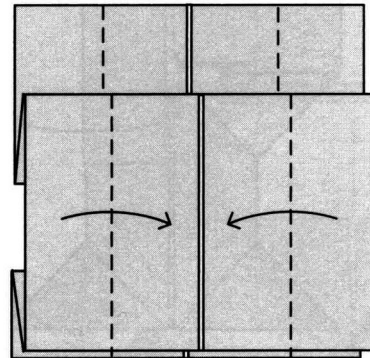
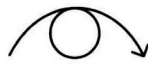

10. Valley-fold the two sides to the center through all thicknesses.

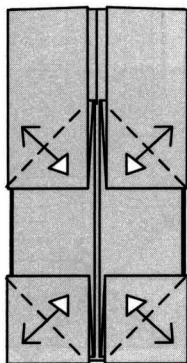

11. Valley-fold the four inside corners outward at 45°. Then unfold.

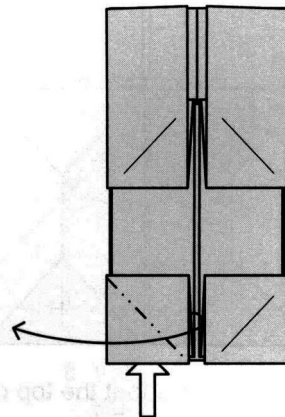

12. Insert your finger under the square flap at the lower left, and open it to the left. When it becomes triangular, squash it flat.

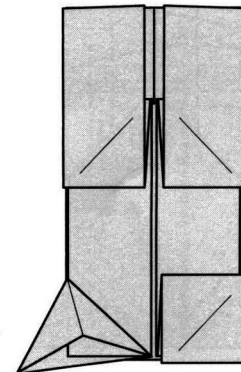

Step 12 in progress

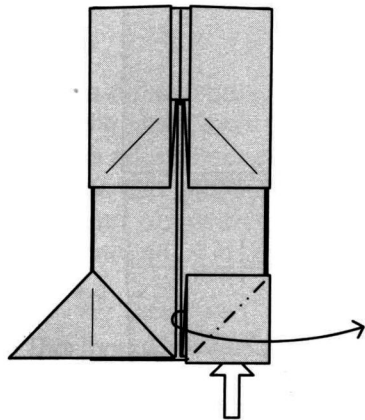

13. Repeat step 12 on the lower right flap.

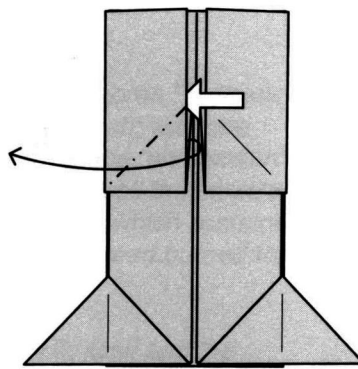

14. Do the same move on the upper left flap.

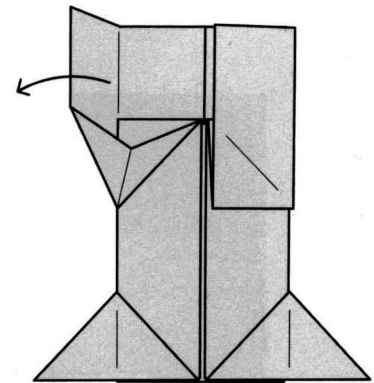

Step 14 in progress

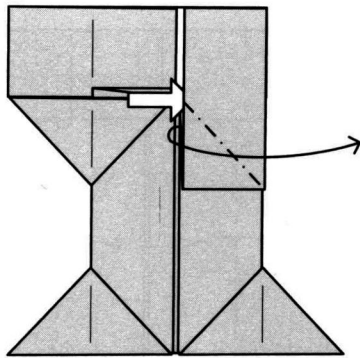

15. Repeat step 14 on the upper right flap.

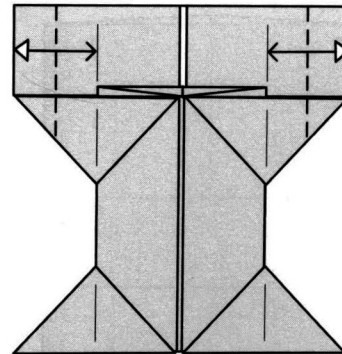

16. Valley-fold and unfold the left and right edges to the creases indicated.

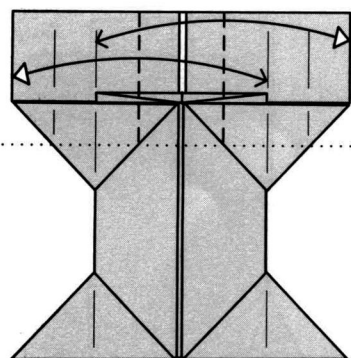

17. Valley-fold and unfold the left and right edges to the same creases as in step 16, but on the opposite side of the model. Only crease down as far as the dotted line.

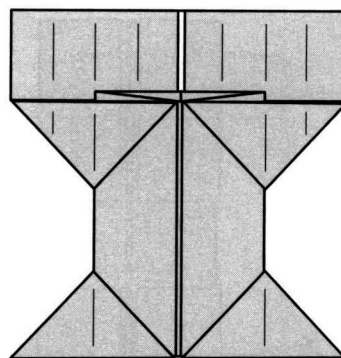

17. The result is that the top of the menorah will be divided into eight sections. Turn the model over.

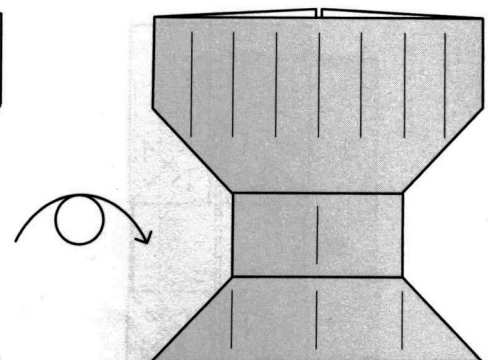

The Menorah

Menorah Candles

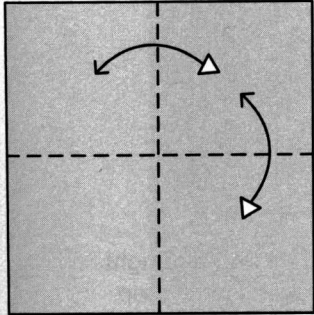

1. Begin with the color side up. Valley-fold and unfold the model side to side in both directions. Then turn the model over.

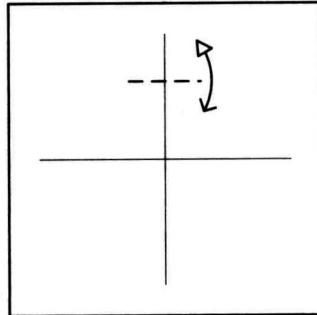
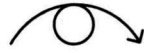

2. Pinch the half-way point between the top edge and the center.

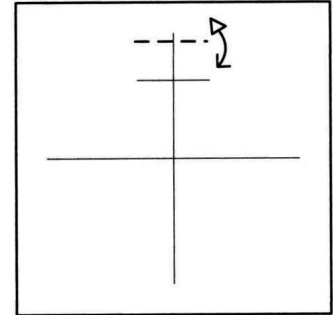

3. Pinch the half-way point between the edge and the pinch mark you made in step 2.

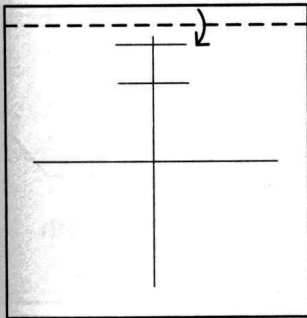

4. Valley-fold the top edge to the pinch mark you made in step 3. This folded area is 1/16 the total distance.

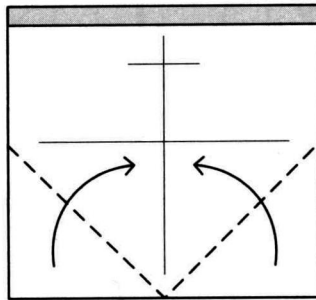

5. Valley-fold both lower corners to the center.

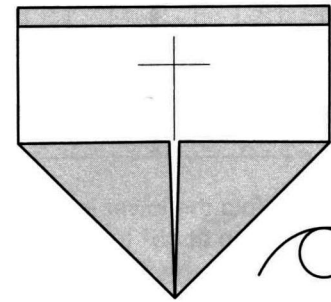

6. Turn the model over.

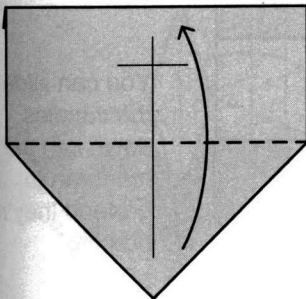

7. Valley-fold the model up at the widest part of the triangular area. The tip will stick out over the top.

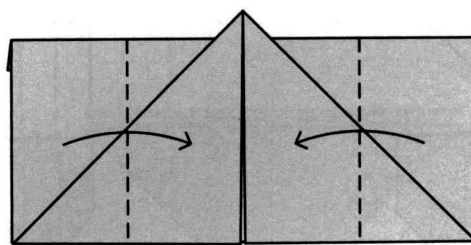

8. Valley-fold both sides to the center.

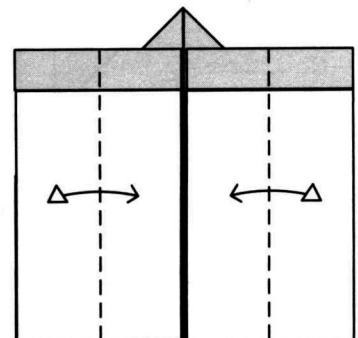

9. Valley-fold and unfold both sides to the center.

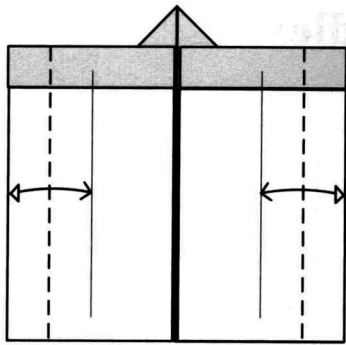

10. Valley-fold and unfold the left and right edges to the creases you made in step 9.

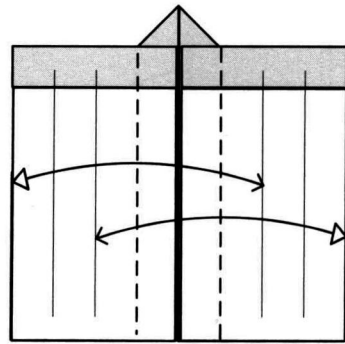

11. Valley-fold and unfold the left and right edges to the same creases as in step 10, but on the opposite side of the model. This makes eight "candles."

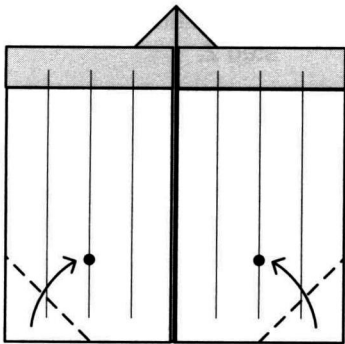

11. Valley-fold the lower left and right corners up at 45° to the dots (the second creases from the right and left).

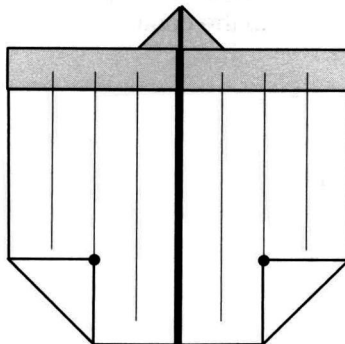

12. Turn the model over.

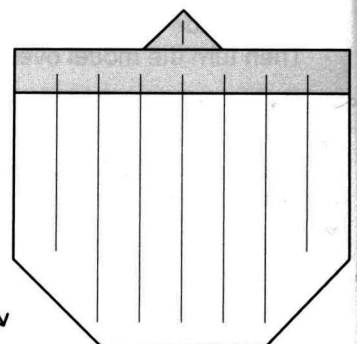
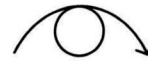

The Menorah Candles

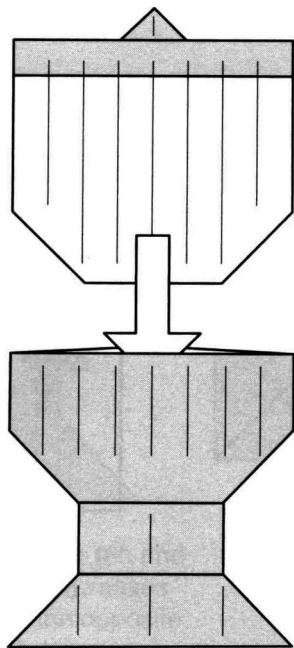

Insert the candles between the front and back flaps of the menorah.

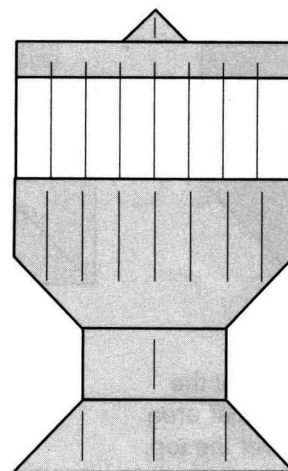

The Menorah with Candles

You can slide the candles down into the menorah to pretend they're burning.

HANUKKAH DREIDEL

During the *Hanukkah* holiday children play a game with a spinning top called a *dreidel*. You can fold paper *dreidels* in many colors as table decorations, hanging mobiles, and for greeting cards.

You need:

One paper square about 6 to 8 inches (15 to 20 cm)

1. Fold paper in half. Unfold.
2. Fold two corners to the crease you just made.
3. Fold both sides to the middle.
4. Fold the short edge to the pointed end.
5. Fold up again, leaving a pleat.
6. Fold the corners in, as shown. Unfold them again.
7. Fold the outside edges to the middle. As you do this, small triangles form. See next drawing. Sharpen all creases.
8. Turn the paper over to the other side.

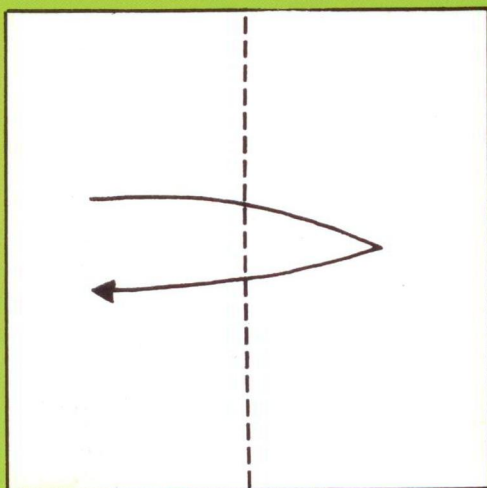
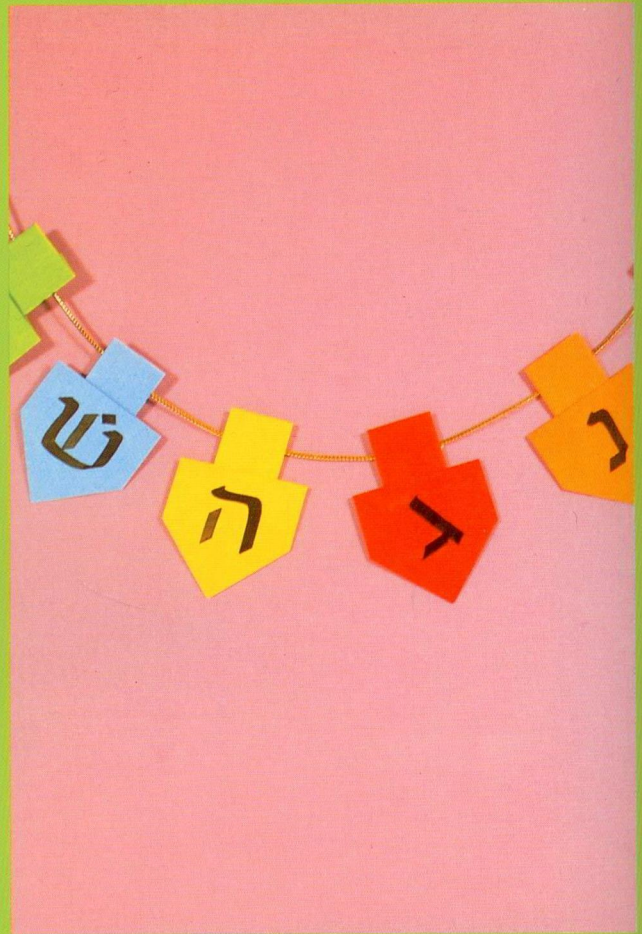

1.

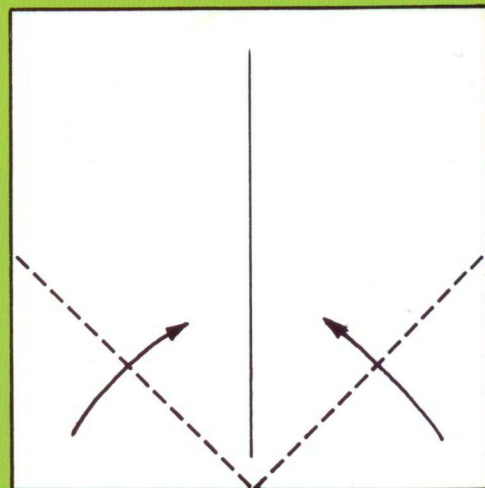

2.

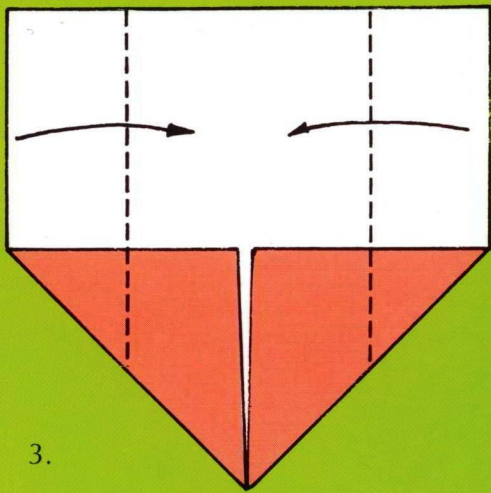

3.

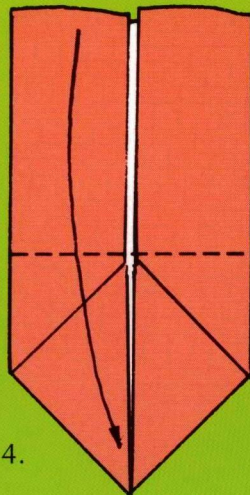

4.

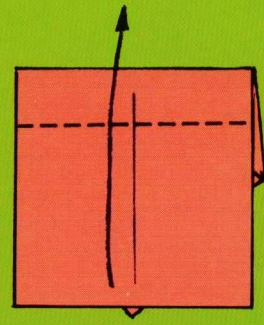

5.

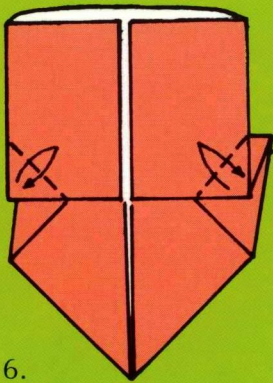

6.

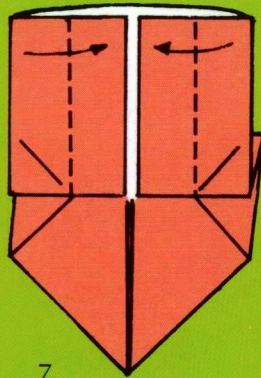

7.

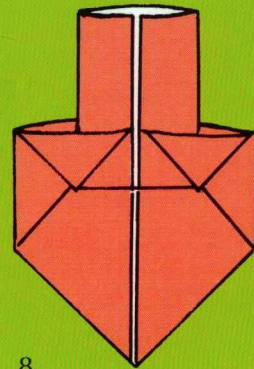

8.

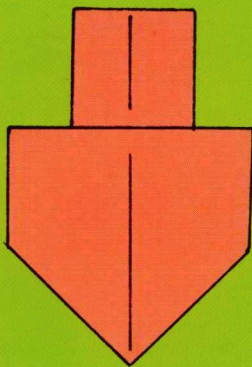

Star of David

(from <http://www.origami-resource-center.com/origami-six-pointed-star.html>)

1

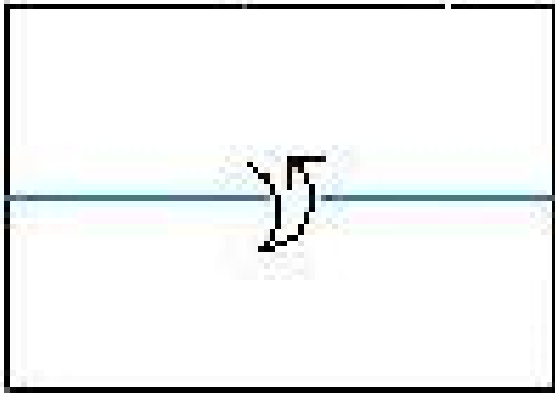

2

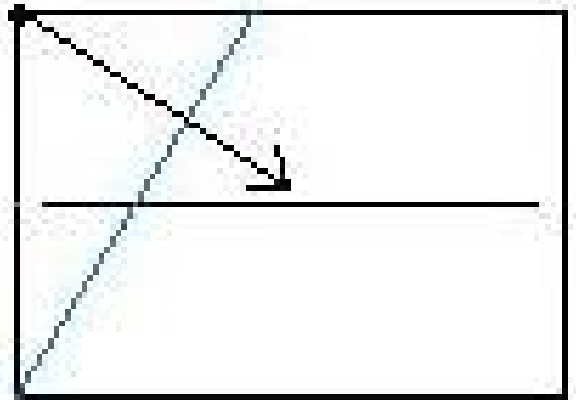

3

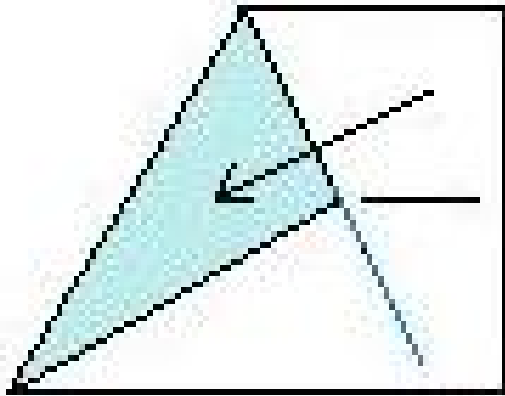

4

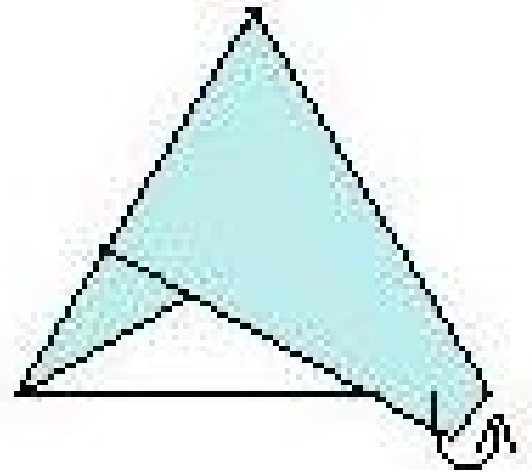

5

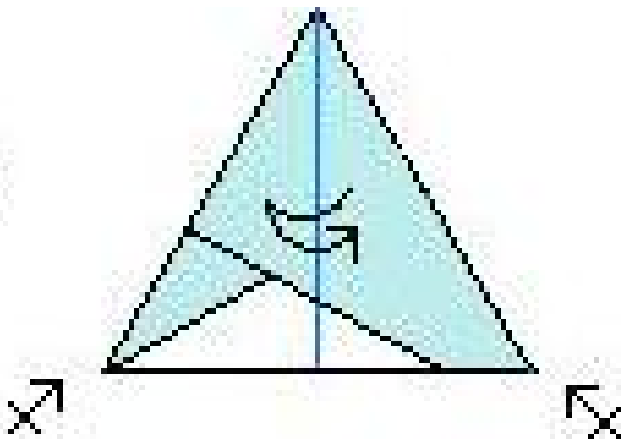

6

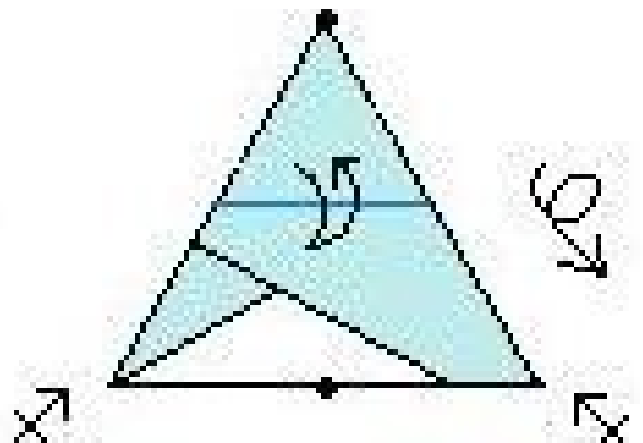

7

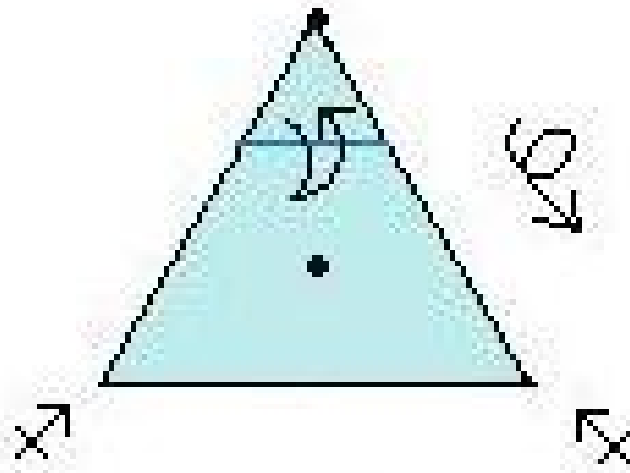

8

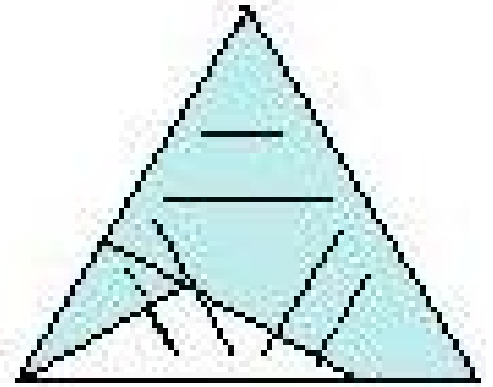

9

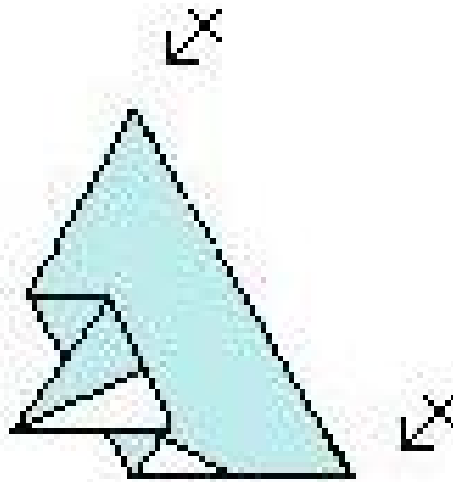

10

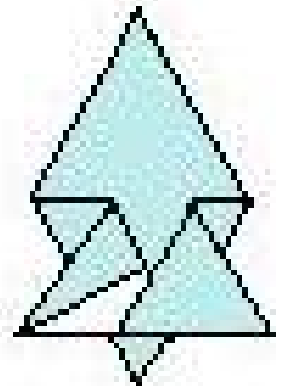

11

